

# VERSAFLOW 4/55

Making the best even better!

The next generation of VERSAFLOW

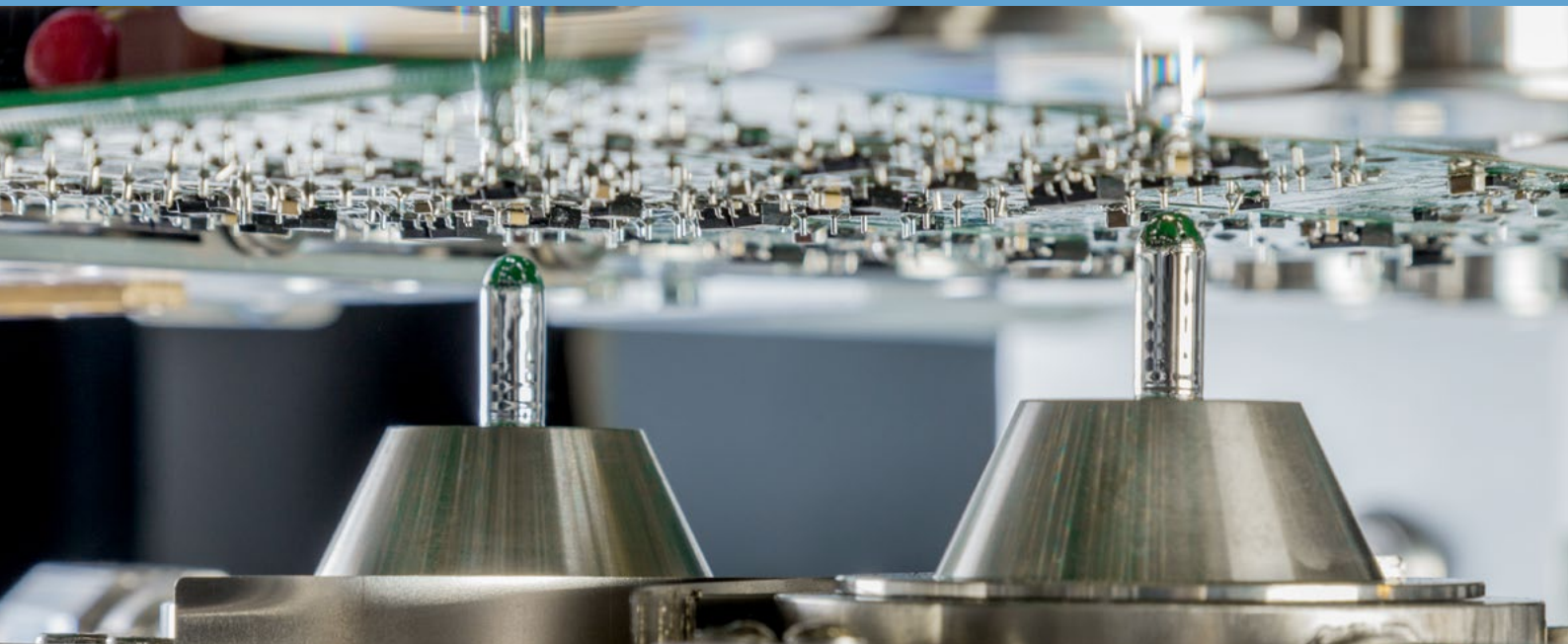

# Ersa VERSAFLOW 4/55

## Fit for the future of selective soldering

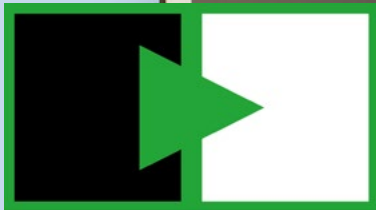

**The Hermes Standard**  
for "M-to-M" in SMT Assembly

### Highlights

- Max. PCB size 508 x 508 mm
- Fluxer Y variable
- Power convection
- Dual pot Y-Z variable
- Automatic nozzle activation
- ERSASOFT 5
- VERSAFLEX
- VERSACAM
- VERSASCAN
- VERSAEYE

The world's leading inline selective soldering system **VERSAFLOW** meets the highest demands in flexibility and throughput. The Ersa **VERSAFLOW 4/55** is the 4<sup>th</sup> generation, built to match production requirements from high volume, low mix to high mix, low volume.

New innovative features make the **VERSAFLOW 4/55** fit for future demands. With almost endless possibilities of configurations, the modular system can ideally be custom-fitted to any requirement. Up to 4 spray heads can be installed in the flux modules of the **VERSAFLOW 4/55**.

Flux application is controlled by a laser system. This enables a safe automated production.

Apart from infrared emitters and convection heaters, the heating module can also be equipped with the new power convection heating ensuring an efficient, safe and homogenous warm-up of even most complex PCBs.

The machine configuration of the **VERSAFLOW 4/55** may include up to 3 solder modules with one or two single wave pots per soldering module. The new **VERSAFLEX** solder module drives the system flexibility to completely new dimensions.



*VERSAFLEX soldering module*

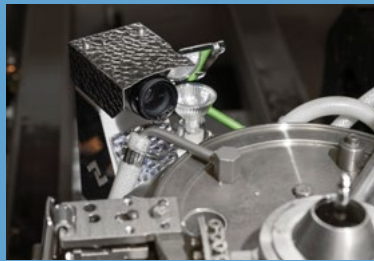

*VERSACAM*



*Dual pot Y-Z variable*



### Basic configuration

- Roller conveyor
- Side fixing in flux module
- ERSASOFT 5
- Precision spray flux system with spray test function and flux level monitoring
- Lower IR preheater
- Maximum PCB size 508 x 508 mm
- PC control with touch screen monitor
- Process visualization including solder protocol, process data writer, monitoring function, maintenance and error message indication, password protection
- Exhaust air monitoring
- Solder bath with electromagnetic solder pump
- Solder level- and solder wave height monitoring

The completely new, intuitively operable system software **ERSASOFT 5** is based on the newest Microsoft technology and operated via a 24" touch-screen. It also permits complete process monitoring and visualization, and it reduces the time required to configure process parameters. Complete process data management, documentation of all process- and system relevant data as well as an interface for the integration of traceability as per ZVEI protocol respectively MES systems are important features.



*Power convection*



*Fluxer, Y variable*



*Automatic nozzle activation*

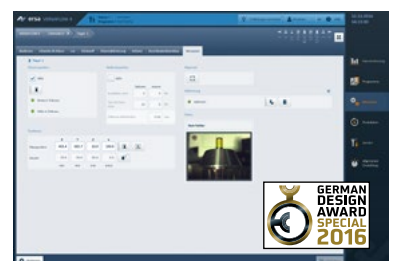

*ERSASOFT 5*

# VERSAFLEX

## Individual adjustment of solder pots in X-Y-Z

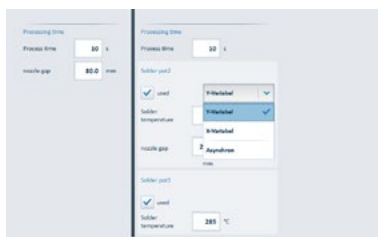

### Highlights

- Simultaneous soldering of PCB panels in X or Y direction
- Highest flexibility at the fastest cycle time
- Automatic cycle time optimization due to offline program generation with CAD Assistant 4

Due to increasing product changes in electronics production, it is necessary to exchange solder nozzles or readjust solder pots by hand.

The Ersaflex VERSAFLEX solder module sets completely new standards with regard to flexibility. As its name already suggests, this solder module is available for the VERSAFLOW 4/55 selective soldering systems and guarantees maximum flexibility.

Like the already existing Ersaflex dual pot systems the innovative VERSAFLEX module offers substantial added value for the production: doubling of throughput with PCB panels, use of different solder alloys or nozzle shapes without any changes required. The two solder pots are installed on

two independent axes. In this way, the pots can be moved and adjusted individually in X-Y-Z direction. Thus PCB panels can be soldered simultaneously in X or Y direction. In addition, the new CAD Assistant 4 offers offline programming with automatic optimization of cycle times. The result is highest flexibility at shortest cycle time.

To meet all of tomorrow's requirements we offer an upgrade package for the innovative VERSAFLEX module making you ready for the future: This update allows to independently solder two individual joints at the same time.

# CAD-Assistant 4

## Fast, intuitive and comfortable

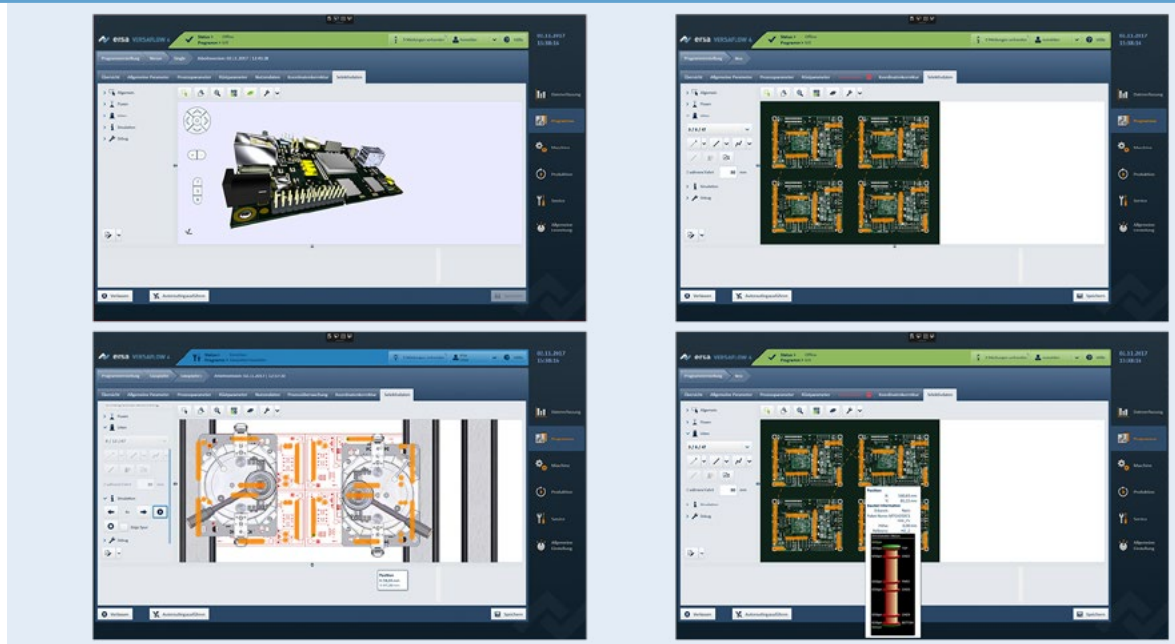

The efficient generation of complex solder programs is of great importance. The Erska CAD Assistant 4 provides for an offline program generation while the machine is in operation! This ensures highest machine availability.

CAD Assistant 4 considers the specific equipment configuration in the generation of a solder program. Furthermore, it supports solder modules with two independent axes (VERSAFLEX). The data sets of the CNC axes are processed using Drag&Drop. Furthermore, CAD Assistant 4 includes pre-defined data sets the user can easily adapt to his specific application. Errors during the program creation are prevented by a plausibility check. Both CAD files of PCBs and image files can be used as basis in the program generation with CAD Assistant 4. All movements of the fluxer as well as

the solder pots are graphically entered on the image of the board, after which the process data is added. Program files created with the CAD Assistant 4 can easily be verified by means of process simulations and can immediately be used in the selective soldering machine.

The software upgrade VERSAFLEX ULTRA provides maximum flexibility and further optimized processes: Both solder pots can be moved fully independently in X-Y-Z. Due to the new autorouting feature, the generation of complex solder programs is super easy: The user only enters the tracks or single joints to be fluxed and soldered. CAD Assistant 4 then automatically sets the machine movements in the most efficient way.

- ### Highlights
- Intuitive programming due to graphic user interface
  - Optimized cycle times by means of auto-routing
  - Automatic and optimized assignment of fluxing and soldering jobs to the available modules
  - Prevention of crashes by the definition of exclusion areas
  - Program simulation to verify settings
  - Support of solder modules with two independent axes (VERSAFLEX)
  - Management of up to 3 solder modules
  - Simple scaling of the assembly
  - File import of CAD formats: ODB++, IPC 2581, GenCAD
  - File import of image formats: .jpg, .bmp, .png, .tif, .gif

# Simple. Clearly Arranged. Efficient.

## Controlling and documenting with ERSASOFT 5

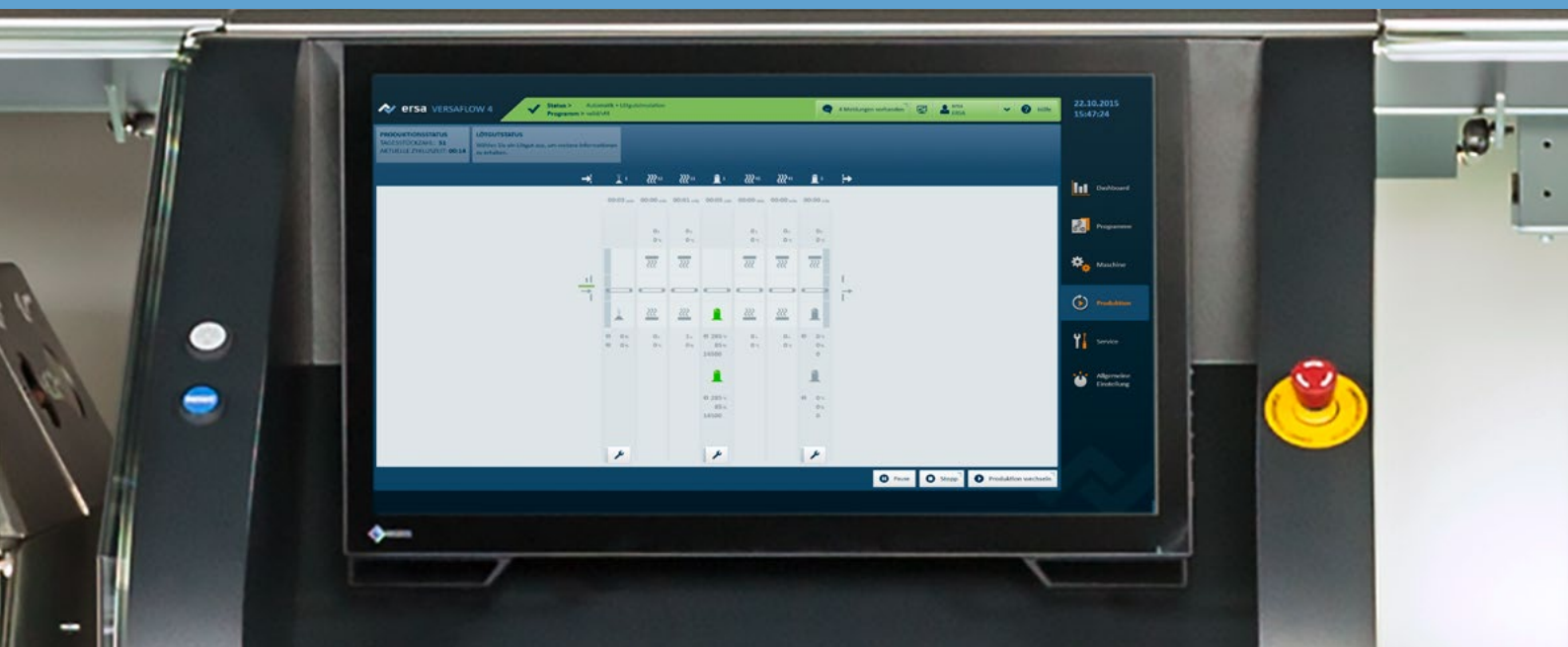

### Highlights

- Intuitive user guidance
- Modern design
- PiP-function/process monitoring
- Individual user interfaces
- Integrated CAD- Assistant



Ersa's selective soldering systems of the 4th generation are delivered with the state-of-the-art ERSASOFT 5 operating software.

The new version of our proven system operation software convinces, aside from with its modern visualization, through its operator oriented, user friendly structure. Through individual user interfaces, each group of operators receives, at one glance, the data and information it requires.

The new interface is also more comfortable in regards to process monitoring. Thanks to modern PiP technology (picture in picture), the solder parameters as well as the process images are available at one glance, providing optimal control for each individual solder process.

Through an additional monitor, up to 6 single nozzles can be permanently displayed for the purpose of process monitoring. By a mouse click, the individual nozzle can be enlarged to full screen for closer observance of the soldering process.



# The Ersa Modular System

## We optimize the soldering process for your specific needs

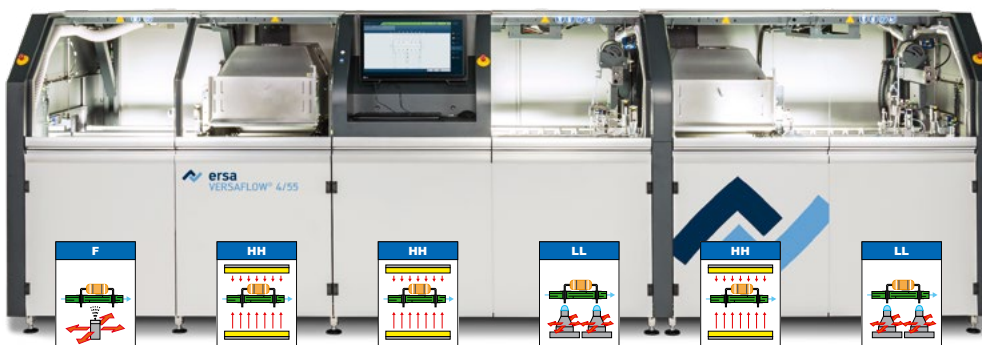
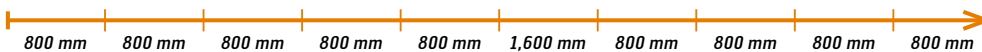
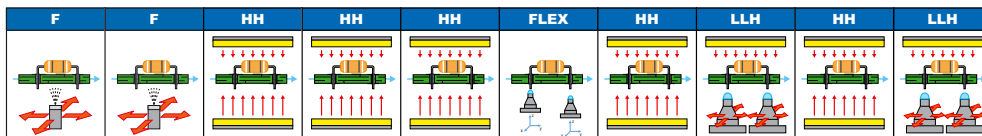
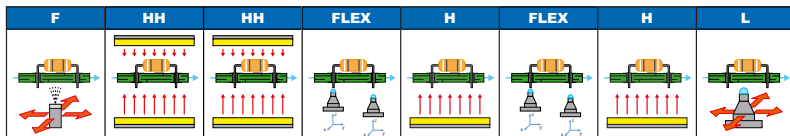
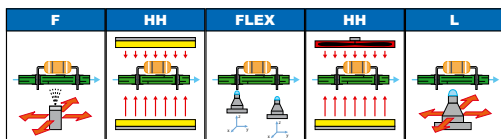
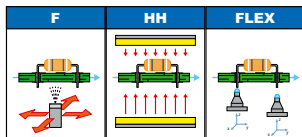
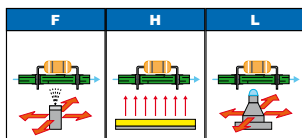

### Configuration examples

The combinations of the arrangement of different modules show only some of the possibilities of the extremely flexible Ersa modular system concept.

Depending on a customer's request, with the addition of the optional dual pot feature, throughput could be substantially enhanced without increasing floor space requirements.

### Legend:

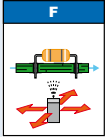
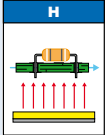
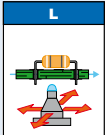
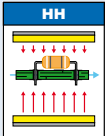
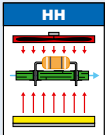
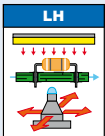
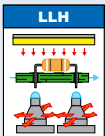
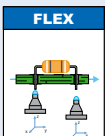
-  Flux module with spray fluxer
-  Preheat module with bottom-side heating
-  Solder module with single pot
-  Preheat module with bottom- and top-side heating
-  Preheat module with power convection
-  Solder module with single pot and top-side heating
-  Solder module with dual pot and top-side heating
-  VERSAFLEX solder module

# Technical data VERSAFLOW 4/55

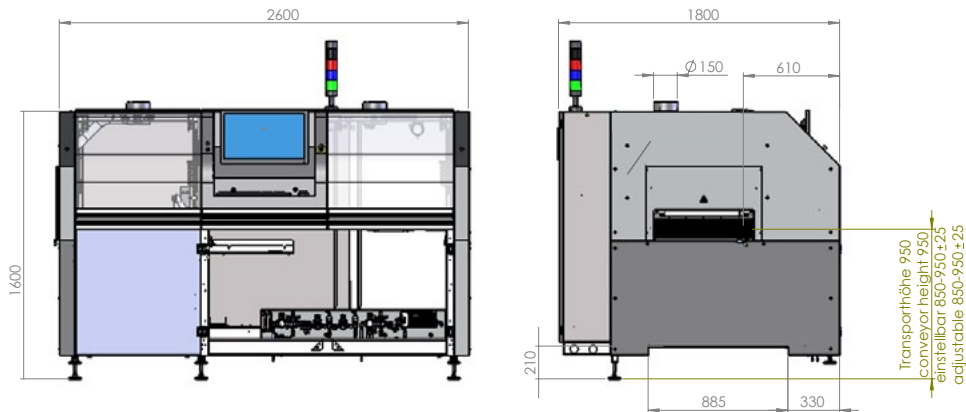

## VERSAFLOW 4/55 (basic system)

Length:	2,600 mm
Width:	1,800 mm
Height:	1,600 mm
Weight:	1,500 kg
Type:	inline
PCB loading:	manual/automatic

## Conveyor system

Type:	roller conveyor
PCB width:	50 – 508 mm (single track)
PCB length:	127 – 508 mm
Clearance from PCB edge:	3 mm
PCB top side clearance:	max. 120 mm
PCB bottom side clearance:	max. 60 mm
Speed:	0.2 – 15 m/min
Mask/PCB weight:	8 kg (heavy load conveyor optional) (15 kg)

## Electrical data

Power:	5-wire system, 3 x 230/400 V, N, PE
Power tolerance range:	±6 %, -10 %
Frequency:	50/60 Hz
Power consumption:	22 kW
Safety fuse:	max. 45 A

## Flux module

Typ:	high-precision spray fluxer
Positioning system:	2 axis, servo motor driven
Flux storage tank:	1.8 l
Positioning speed:	1 – 400 mm/s
Fluxer speed:	20 mm/s
Positioning accuracy:	±0.15 mm
Spray width:	2 – 8 mm (130 µm nozzle)

## Preheat module

Type:	IR bottom-side (basis), top-side convection (option), top side power convection (option)
Power:	12 kW per IR heater, 5 kW (convection), 6 kW (power convection)
Temperature:	200 °C

## Nitrogen technology

Nitrogen supply:	to be supplied locally
Nitrogen injection:	N <sub>2</sub> cover over the solder bath
Required pressure:	6 bar
Consumption:	approx. 1.5 m <sup>3</sup> /h per pot
Particle cleanliness: (recommendation)	5.0

## Miniwave solder module

Solder wave height:	max. 5 mm
Clearance from PCB edge:	min. 3 mm
Solder volume:	approx. 14 kg (Sn63Pb) approx. 13 kg (lead-free)
Solder temperature:	max. 330 °C
Warm-up time:	75 min to 280 °C
Positioning speed:	X/Y; 2 – 200 mm/s
Soldering speed:	10 mm/s
Positioning accuracy:	±0.15 mm

## Compressed air

Compressed air supply:	to be supplied locally
Required pressure:	6 bar
Consumption :	< 5 m <sup>3</sup> /h

## Exhaust rating

Exhaust stacks:	2 pc., OD 150 mm
Exhaust volume per stack:	300 m <sup>3</sup> /h

## Environmental specs/noise level

Ambient temperature:	15 – 35 °C
Permanent sound level:	<65 dB(A)

## America

Ersa North America  
info-ena@kurtzera.com

## Mexico

Kurtz Ersa, S.A. de C.V.  
info-kmx@kurtzera.com

## Asia

Kurtz Ersa Asia Ltd.  
info-eap@kurtzera.com

## China

Ersa Shanghai  
info-esh@kurtzera.com

## France

Ersa France  
info-efr@kurtzera.com